

PROCEEDINGS OF SPIE

[SPIDigitalLibrary.org/conference-proceedings-of-spie](https://spiedigitallibrary.org/conference-proceedings-of-spie)

The WEAVE observatory control system

Sergio Picó, Don Carlos Abrams, Chris Benn, Lilian Dominguez, Cecilia Fariña, et al.

Sergio Picó, Don Carlos Abrams, Chris Benn, Lilian Dominguez, Cecilia Fariña, Jose Miguel Delgado, Carlos Martin, Diego Cano, Bernardo Salasnich, Steve Guest, Frank Gribbin, Jure Skvarč, Emanuel Gafton, Gavin Dalton, Kevin Middleton, Scott Trager, J. Alfonso Aguerri, Piercarlo Bonifacio, Antonella Vallenari, Esperanza Carrasco, "The WEAVE observatory control system," Proc. SPIE 10704, Observatory Operations: Strategies, Processes, and Systems VII, 107042A (10 July 2018); doi: 10.1117/12.2312638

SPIE.

Event: SPIE Astronomical Telescopes + Instrumentation, 2018, Austin, Texas, United States

The WEAVE Observatory Control System

Sergio Picó ^{*a}, Don Carlos Abrams ^a, Chris Benn ^a, Lilian Dominguez ^a, Cecilia Fariña ^a, Jose Miguel Delgado ^b, Carlos Martin ^a, Diego Cano ^a, Bernardo Salasnich ^c, Steve Guest ^d, Frank Gribbin ^a, Jure Skvarč ^a, Emanuel Gafton ^a, Gavin Dalton ^{d,e}, Kevin Middleton ^d, Scott Tragger ^f, J. Alfonso Aguerri ^b, Piercarlo Bonifacio ^g, Antonella Vallenari ^c, Esperanza Carrasco ^h

^a Isaac Newton Group, 38700 Santa Cruz de La Palma, Spain; ^b Instituto de Astrofísica de Canarias, 38200 La Laguna, Tenerife, Spain; ^c Osservatorio Astronomico di Padova, INAF, Vicolo Osservatorio 5, 35122, Padova, Italy; ^dRALSpace, STFC Rutherford Appleton Laboratory, Harwell Oxford, OX11 0QX, UK; ^eDept. of Physics, University of Oxford, Keble Road, Oxford, OX1 3RH, UK; ^fKapteyn Institut, Rijksuniversiteit Groningen, Postbus 800, NL-9700 AV Groningen, Netherlands; ^g GEPI, Observatoire de Paris, Université PSL, CNRS, Place Jules Janssen, 92195 Meudon, France; ^hINAOE, Luis Enrique Erro 1, Tonantzintla, Puebla, Mexico;

*spico@ing.iac.es

ABSTRACT

WEAVE is the next-generation spectroscopic facility for the William Herschel Telescope (WHT) ^{1,2}. WEAVE offers multi-object (1000 fibres) and integral-field spectroscopy at two resolutions ($R \sim 5000, 20000$) over a 2-deg field of view at prime focus and will mainly provide follow up of ground-based (LOFAR) and space-based (GAIA) surveys.

The **Observatory Control System** (OCS) is responsible for providing the software control and feedback framework through which WEAVE will be operated. This paper summarizes the design of the different OCS subsystems and the interfaces between them and other WEAVE components.

In the remainder of this paper, Section 2 outlines the other WEAVE systems with which the OCS interacts, Section 3 describes the system architecture, Section 4 comments on system-architecture decisions, Section 5 describes the main components of the OCS, Section 6 outlines the life-cycle of an OCS Observing Block and, finally, Section 7 gives an overview of the OCS testing plan.

Keywords: WEAVE, software architecture, scheduler, sequencer, observing block, CORBA, PLCIO, FITS, GWT, PAC, ARC controller

1. INTRODUCTION

The Observatory Control System (OCS) is responsible for controlling the WEAVE instrument operation. It is built upon the existing software infrastructure in place at the WHT, the Instrument Control System (ICS), adding scheduling and sequencing capabilities.

The information regarding a given WEAVE observation is organized into **Observing Blocks** (OB) and stored in the OB Database. The OB stored in the OB database will subsequently be used as input to the **Observation Queue Scheduler** (OQS) ¹⁰. The OQS embodies a decision management system which accepts various input constraints and produces a ranked list of candidate OBs to be observed.

The OQS interfaces with the OCS **Sequencer** passing information about which OB to execute next or configuring task execute next.

The WEAVE Observation Sequencer is responsible for translating the instrument configuration held in an OB into a physical configuration of the instrument by configuring the various control subsystems that comprise WEAVE.

1.1 The WEAVE Instrument

The main components of the WEAVE instrument are:

- A prime focus corrector for the WHT.
- Two plates for fibre positioning and a tumbler which can rotate to position any of them in the focal plane
- A positioner, which configures MOS fibres or integral-field units (IFUs) on one plate while observations are carried out with the other plate.
- A two-arm (blue and red) spectrograph
- A calibration unit which hosts a set of lamps for calibration images

WEAVE can be operated in 3 modes:

- MOS: Multi-object spectroscopy, provided by 960 and 940 configurable fibres on plate A and plate B, respectively.
- mIFU: 20 mini-IFUs on plate B
- LIFU: Large IFU, positioned in the focal plane by rotating the tumbler to a position 90 deg between those of plate A and plate B

1.2 System responsibilities

The OCS is responsible for:

- Converting field definition XML files into OBs.
- Storing all the information relevant to the OB definitions and execution in the OB database.
- Assisting the user in examining the characteristics of the OBs and the state of their execution.
- Assisting the user in making a decision in relation to which OB is most suitable for execution.
- Translating the instrument configuration information held in an OB into a physical configuration of the instrument.
- Executing the actions associated with the OB.
- Producing the science and calibration integrations associated with the OBs.
- Analysing the quality of the integrations.
- Providing an accurate view of the instrument state and the OB execution.

2. SYSTEM INTERFACES

The OCS is one of the nine systems that constitute WEAVE and is responsible for controlling the WEAVE instrument, carrying out the exposures and creating the data files. The other systems include:

- a) The Prime Focus Corrector System⁵ which is responsible for the delivery of the corrector, the rotator and the instrument mounting platform. They are controlled by the Telescope Control system (TCS).
- b) The Fibre Positioner System⁹ which consists of the pick-and-place fibre positioner and the subsystem that controls the fibre positioner. The fibre positioner configures the fibres to their correct position for each field.
- c) The Fibre System which is responsible for delivery all the fibres.
- d) The Spectrograph System³ which is responsible for the delivery of the spectrograph and the science detectors. The OCS provides the control subsystem for the spectrograph and the data acquisition subsystem for the detectors.

- e) The Core Processing System (CPS) ⁶ which is responsible for basic quality control, image processing and spectral extraction. The image files produced by the OCS are transferred to CPS.
- f) The Advanced Processing System which is responsible for the high-level science analysis.
- g) The WEAVE Archive System ⁷ which is responsible for storing the images and providing controlled access to them.
- h) The WHT Support Facilities which is responsible for modifying the WHT to allow WEAVE to be integrated with the telescope.

The relationship between the systems, which interface with the OCS, are shown in Figure 1.

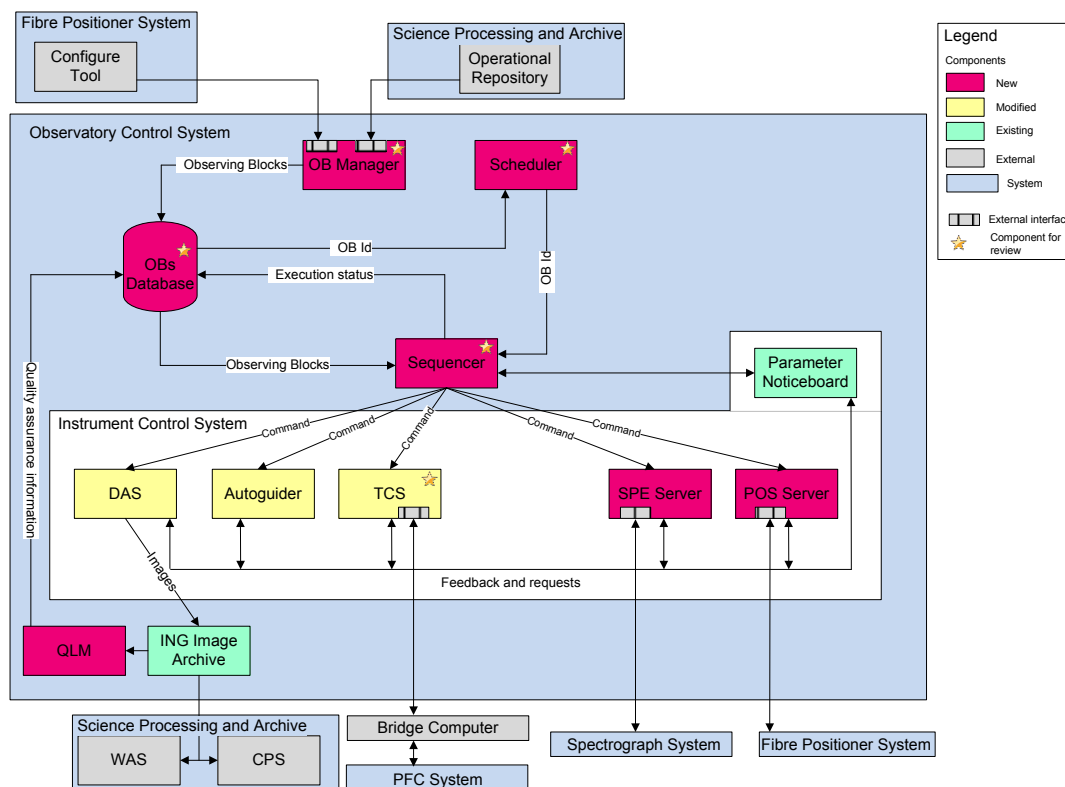



Figure 1: An overview of the relationship between the OCS and those systems which have an interface with it. The external interfaces are shown with a  symbol.

3. SYSTEM ARCHITECTURE DESCRIPTION

The information regarding the field definitions and instrument configuration is produced by the Survey Working Group (SWG) in form of XML files and deposited in the **Operational repository** (OR).

The OCS retrieves the field definitions from the OR and translates them into OBs. An OB contains the complete information set required to configure the WEAVE instrument, the telescope and the data acquisition systems in order to perform a series of calibrations and science integrations.

The component responsible for performing that conversion is the **OB Manager**.

The OB Manager also offers to the ‘**On-island Survey Management Team**’ (OISMT) a set of facilities, in the form of GUIs, to examine the characteristics of the OBs and the state of their execution.

The OBs are stored in the **OB database** and will subsequently be used as input to the **Observation Queue Scheduler (OQS)**. The purpose of this software is to assist the WEAVE operator in making an informed decision with respect to which OB in the database is most suitable for observation. The OQS uses a bespoke scheduling algorithm producing a ranked list of candidate OBs to be observed.

The OQS interfaces with the OCS **Sequencer** indicating which OB to execute next or to configure on the plate currently out of the light path (there are two plates: A and B)¹.

The WEAVE Observation Sequencer is responsible for translating the instrument configuration held in an OB into a physical configuration of the instrument by configuring the various control subsystems that comprise WEAVE.

The Sequencer is also responsible for the execution of the series of actions associated with the OB. For that, it interfaces with all the subsystems that comprise the WEAVE instrument:

- **The Spectrograph Control system:** this subsystem is divided into two layers: the low-level software in the embedded control system (PAC)⁴, the high-level control and feedback coordination server that resides in the WEAVE OCS.
- **The UltraDAS and Autoguider system:** Both are based on the existing ING system. UltraDAS (DAS) has the responsibility of controlling and performing data acquisition from the WEAVE science detectors and creating science data files in a valid FITS format suitable for processing by the WEAVE data reduction system. The Autoguider (AG) System will, depending on the mode of the instrument, utilise one or more of the various coherent guide fibre bundles which will provide it with the necessary input signals such that it can calculate guiding corrections. These guiding corrections will subsequently be sent to the Telescope Control System in order to effect the correction. The Autoguider System for the LIFU will image the sky directly and perform the calculations necessary to provide the guiding corrections to the Telescope Control System.
- **The Prime Focus Corrector system:** this subsystem is embedded in an Allen-Bradley PAC and it is responsible for controlling the WEAVE rotator, telescope focus⁴ and the ADC unit. It is interfaced to the TCS using the standard PLCIO library.
- **The TCS:** The WHT Telescope Control System is an existing product. Its purpose is to point the telescope at an astronomical object, to track and focus it accurately and to perform offsets as required during the observation. It also drives the PFC system described above.
- **The Fibre Positioner control system**⁹: This subsystem does not belong to the OCS. It is responsible for the control of the Fibre Positioner mechanisms and offers an interface to the OCS. A dedicated component of the ICS, called **POSOCS**, will be in charge of making the Positioner information available to the rest of OCS components and creating the related FITS headers.

In order to ensure that all control requests to the WEAVE instrumentation are both consistent in their nature and robust in their execution, the WEAVE Instrument Control System (ICS) provides the software control and feedback framework through which the WEAVE operator will perform WEAVE-based, science related operations.

One of the key components of the ICS is the WHT global status cache, called the **Parameter Notice Board (PNB)**. It provides a single point of reference for any WEAVE OCS client that wishes to determine the status of any part of the WEAVE control system. It will be the responsibility of each of the individual subsystems, which comprise WEAVE, to ensure the transfer of their status information into the Parameter Noticeboard in a timely manner. Clients will be able to subscribe to status items within the PNB. Should the status item in the Parameter Noticeboard be updated, the client will be duly informed by the Parameter Noticeboard.

Other important ICS components are:

The **OCS Database:** the SQL database that will be used for the storage of persistent data that is used by the system.

The **Packet collector task:** is used to gather all the information needed to write the FITS headers into the exposure files.

The **talker log:** this component is available for reviewing the system logs and effectively locating information of interest.

The **observation log**: allows the WEAVE operator to review the WEAVE-based integrations that have been produced throughout the evening's operation.

The ICS already exists at the WHT.

Once the science and calibration integrations are produced, they will be analysed by the **Quick-look Module (QLM)** which provides feedback to the operator about the quality of the data obtained. The results of the QLM are also stored in the FITS files and read by an ICS component, called the **QLMWatcher** which stores them into the OB database.

An OB has a state associated throughout its lifetime, from its creation to its execution (and the analysis performed afterwards by the QLM). If the QLM analysis is positive, the QLMWatcher will set the state of the OB to COMPLETE in the OB database. If the QLM analysis is negative, the QLMWatcher sets the OB state to INCOMPLETE.

Figure 2 shows the OCS data flow.

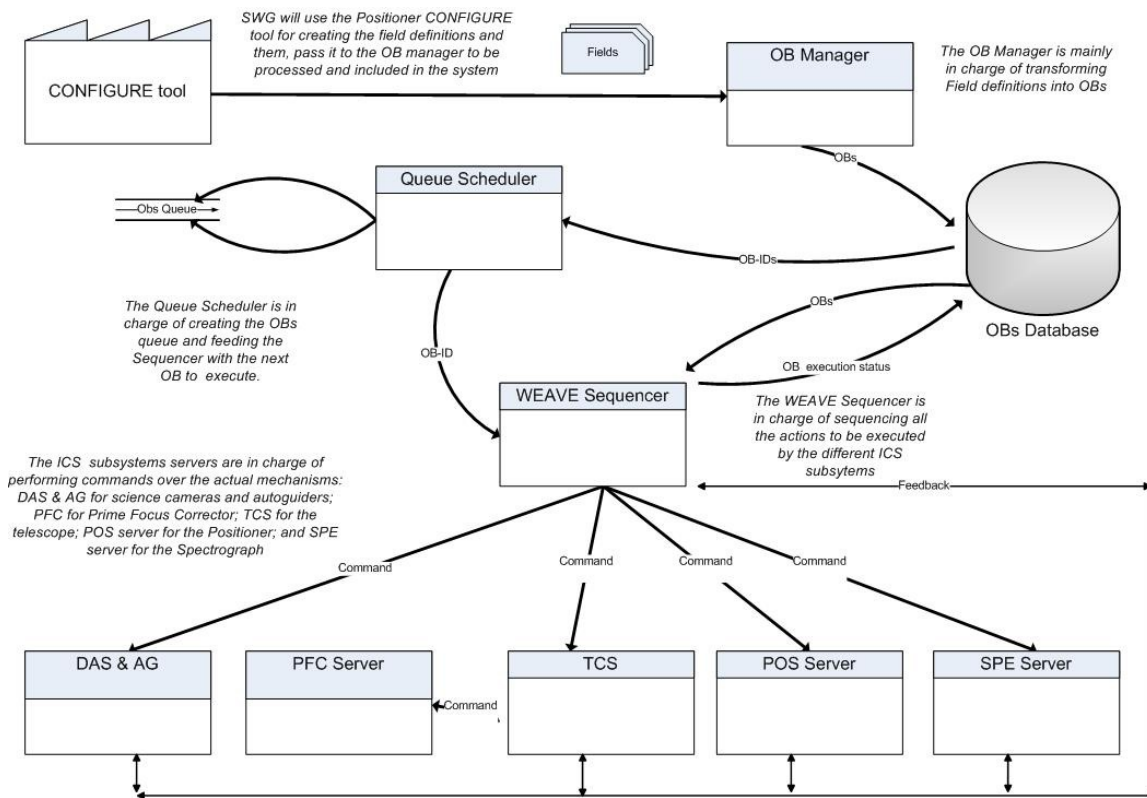

Figure 2 OCS data flow

4. SYSTEM ARCHITECTURE DECISIONS

In general, the OCS architecture design follows the tools, frameworks and techniques used currently with the WHT Instrument Control System (ICS).

4.1 Software design views

Logical view

Each component of the OCS has been modelled taking as a starting point the functional requirements captured from two project documents: 'WEAVE Concept of Operations' and 'WEAVE Instrument Development Specification'.

In addition, when designing the user interfaces, the current behaviour and “look and feel” of the existing WHT ICS has been adopted. This ensures a level of technical consistency between the existing system and the new items that will be created for WEAVE thus maximising the reusability of the WHT ICS and minimising development time for the WEAVE OCS components. Similarly, since ING users are very familiar with the WHT ICS, basing the WEAVE OCS on the existing system reduces the time required for the users to learn the new tools.

Process view

Special care has been taken to define the interfaces between each OCS subsystem and the interfaces with other WEAVE systems (described in an Interface control document, ICD, for each interface). The OCS subsystems offer a **CORBA**-based server able to deal with and dispatch concurrent requests (with the exception of the OB manager, where the [Google Web Toolkit](#) framework provides the infrastructure to deal with simultaneous requests).

Physical view

The distribution of the components has been modelled following the current deployment model of the WHT ICS. The spectrograph and prime focus control subsystems are implemented over Programmable Automation Controllers (PAC) following the philosophy and processes used at the WHT to control existing instruments (e.g. ISIS and the A&G Box).

Architectural Styles

A double model of client-server and centralized global cache system is used for inter-process communication:

There is a server for each hardware control subsystem (spectrograph, Fibre Positioner System, the cameras, and the telescope) dedicated to respond to the actions required by any client (GUIs, command line commands and the WEAVE sequencer). In addition, each of these servers publishes relevant data into the existing WHT global cache, the Parameter Noticeboard, from where any other OCS component can retrieve it.

The persistent information used by OCS to hold reference data is stored in the current ICS relational database.

The transactional data is organized in a dedicated relational database around the concept of Observing Blocks (OB) which holds all the information related to the WEAVE observations.

Families of Programs and Frameworks

The reuse of software designs and components has been key when designing the WEAVE OCS software. As described previously, the communication between server and GUIs uses the existing WHT ICS framework.

The final product of the OCS, the data files in **FITS** format, is produced using the current WHT standard. The OB Manager is based on a servlet-client structure held on the WHT web server and reuses components of other ING similar products such as the Fault Database or the watcher for the detector systems.

The OCS sequencer is built upon the existing ING sequencer called ‘El secuenciador’.

For designing the OCS queue scheduler, we have consulted different institutions with previous experience in scheduled-based observations (Mercator, TNG and Liverpool telescopes).

5. DESCRIPTION OF THE OCS MAIN COMPONENTS

5.1 OB Manager

The OB Manager is the software component of the WEAVE Observatory Control System that is responsible for building and managing the Observation Blocks (OB) that are based on the field definitions that will be provided by the Survey working group (SWG).

An OB comprises the following information:

- The definition of the exposures to be carried on

- The instrument configuration
- The results of its execution
- The result of the Quick look analysis

The system is based on a client-server architecture, where the server is responsible for executing user requests and internal calculations, while the client side acts as a front-end for the operator.

The server side is responsible for:

- Creating OBs based on the fields defined in the XML files produced by the Fibre Positioner's Configure tool.
- Connecting and communicating with the OB Database.
- Responding to client-side queries.

The client side is responsible for:

- Providing the user with information about the creation and execution of OBs
- Providing the user with information about the targets and assigned fibres
- Assisting the user in controlling the field conversion process
- Assisting with the insertion of the survey programmes

The server side is a servlet running within the [Apache Tomcat](#) web server. It is the single point of access to the OB Database and this will be responsible for responding to queries from the client side.

The client side is a Graphical User Interface (GUI) running on any web browser from within the ING intranet.

Both server and client have been developed using Java 1.8 and the Google Web Toolkit 2.7.0 framework.

Figure 3 shows the OB Manager GUI.

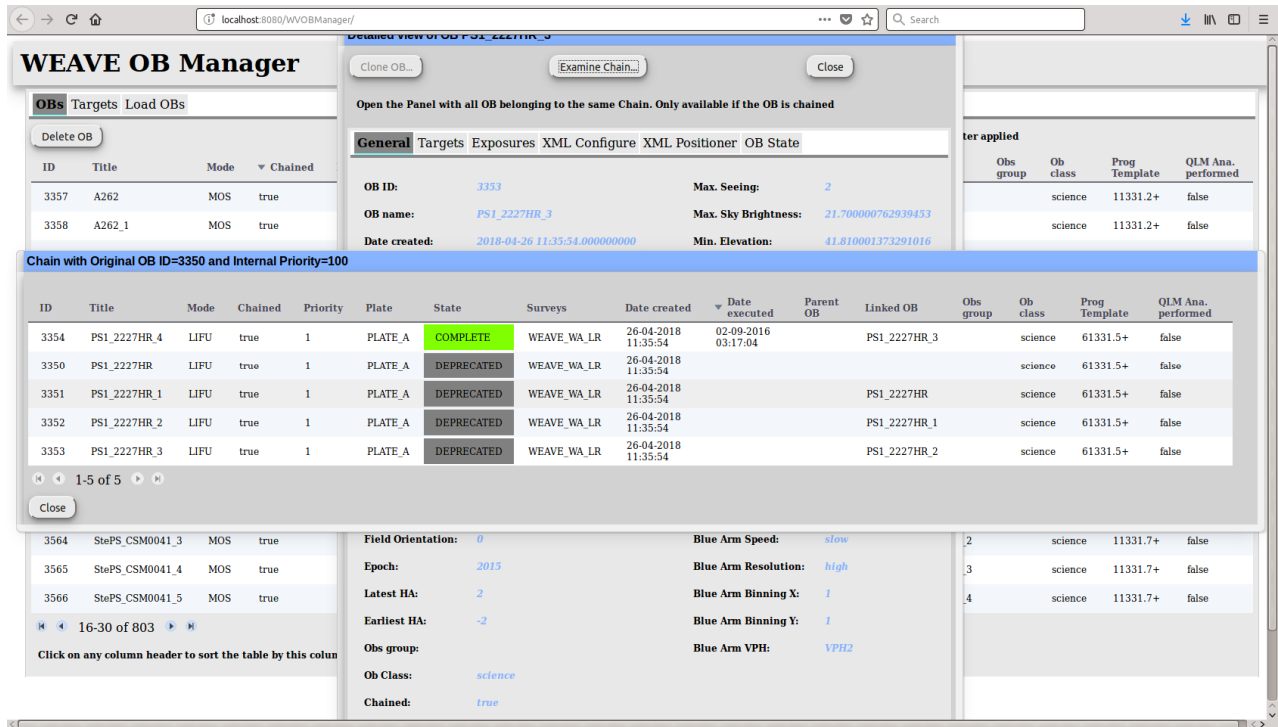

Figure 3 Snapshot of the current status of the OB manager GUI development

5.2 OB Database

The Observing Blocks Database stores all the relevant information related to the definition of the WEAVE Observing Blocks, including a snapshot of the instrument configuration from the moment the OB is finished.

Conceptually there are two types of Observing Blocks: science Observing Blocks and calibration Observing Blocks. The information related to the science Observing Blocks is provided by the Science Teams in the form of field definitions obtained from the Fibre Positioner Configure which are then processed and loaded into the database by the Observing Block Manager tool. The information related to the calibration OBs is generated by the WEAVE Queue Scheduler tool when the WEAVE operator inserts a calibration OB into the queue.

In addition, the information regarding the exposures (FITS file name) and the actual configuration of the instrument will be loaded into the database after the OB execution.

5.3 Observation Queue Scheduler

The purpose of the OQS¹⁰ is to maximise the scientific impact of a night of observations by scheduling the OBs (basically, telescope pointings) according to science priority, required instrument configuration (and current instrumental constraints) and required observing conditions (and current/predicted observing conditions).

Each OB provides the OQS with the OB science priority, RA/Dec of field centre, required instrument mode (MOS, mIFUs, LIFU)¹, instrument configuration (high-resolution, low-resolution), and the required observing conditions (sky brightness, minimum lunar angular distance, transparency, seeing and airmass).

The OQS will need to know about any current instrumental constraints (e.g. mIFU mode not currently available, or change in elevation limit of telescope due to dome-shutter problem). It will also need to know about the overheads incurred for a given change in telescope (e.g. azimuth slew) or instrument (e.g. switch between high- and low-resolution) configuration.

The scheduler will have access to the estimated (current and/or predicted) observing conditions for the coordinates and anticipated time of execution of the OB. The current conditions are provided by the usual external monitors (the weather station), and by the WEAVE autoguider. An algorithm for deciding which source of data to use, for e.g. seeing, will be provided¹⁰. A predictive algorithm for each observing condition will also be provided by the ING astronomers, and it will be possible for observers to enter observing conditions manually. The scheduler will need to know the phase and RA/Dec of the moon at any given UT.

In summary, then, the OQS takes into account the following parameters when selecting an OB to add to the queue:

- Science priority of the OB
- Instrument mode (MOS-A, MOS-B, mIFUs or LIFU)
- Instrument configuration (low-resolution, high-resolution, choice of disperser where relevant)
- Current constraints on instrumental mode and configuration (e.g. plate B not available, lower limit of 40 deg on elevation)
- Seeing, sky brightness, lunar angular distance and sky transparency at the position of the OB (required and currently estimated)
- RA and Dec of the OB field centre, and sidereal time, i.e. object visibility and airmass
- Overheads for changes in telescope and instrument configuration

Scoring function

The Scheduler creates a queue of OBs for each night using as input the parameters described above. It first pre-selects a set of available and visible OBs for the night, and then evaluates each constraint with a scoring function (f_i). The final score of an OB for a given time slot comes from the sum of the weighted (w_i) scoring functions of each constraint:

$$S_{total} = \sum w_i * f_i \quad \text{if } f_i \neq 0 \quad (\text{if all constraints are fulfilled})$$

$$S_{total} = 0 \quad \text{if } f_i = 0 \text{ (if any constraint is not fulfilled)}$$

There are two main types of constraints:

Hard constraints (must be satisfied)

- Telescope constraints (field visibility, blind spot**)
- Minimum elevation
- Moon distance
- Observing mode (MOS A, MOS B, mIFU, LIFU)

** *The blind spot constraint is zenith distance 4 degrees. This is to avoid the WEAVE high-speed rotation issues near zenith, which might affect the quality of the observed data.*

The scoring function for this type of constraint takes binary values, 0 or 1.

If any of these constraints is not fulfilled for a given time slot, the OB is rejected. And if it is fulfilled the scoring function is 1, so they work as a filter.

Optimizable constraints (must be satisfied and optimized)

- Observing conditions (seeing, sky transparency, sky brightness, hour angle)
- Observing priorities: science priority, internal priorities
- Overheads (telescope slew time, instrument set up change, fibre configuration)

The designed scoring functions that evaluate each of these constraints are created in such a way that for given e.g. observing conditions, the scoring functions get higher values as more restrictive the OB constraints and the better the current conditions are.

The overhead function is higher as overheads are shorter, and the priority function is proportional to the science priority of the OB.

The weight w_i assigned to each constraint reflects its perceived importance relative to other constraints.

The scheduler allows one to modify weights to account for temporary adjustments.

Scheduler GUI

Through this GUI the observer will be able to create an observation queue and subsequently execute the observation blocks contained within that queue. In addition to the OBs that are currently stored in the OB database as a result of observers defining the observation programme, it will be possible for the WEAVE observer to create ad hoc OBs to be executed as required e.g. to perform calibrations etc. The software will then send OBs to the Sequencer as requested for execution, either individually or as a sequential list.

The software also provides visualization tools which will allow the observer to see how the OBs are distributed on the sky and over other parameters.

Figure 4 shows the OQS GUI.

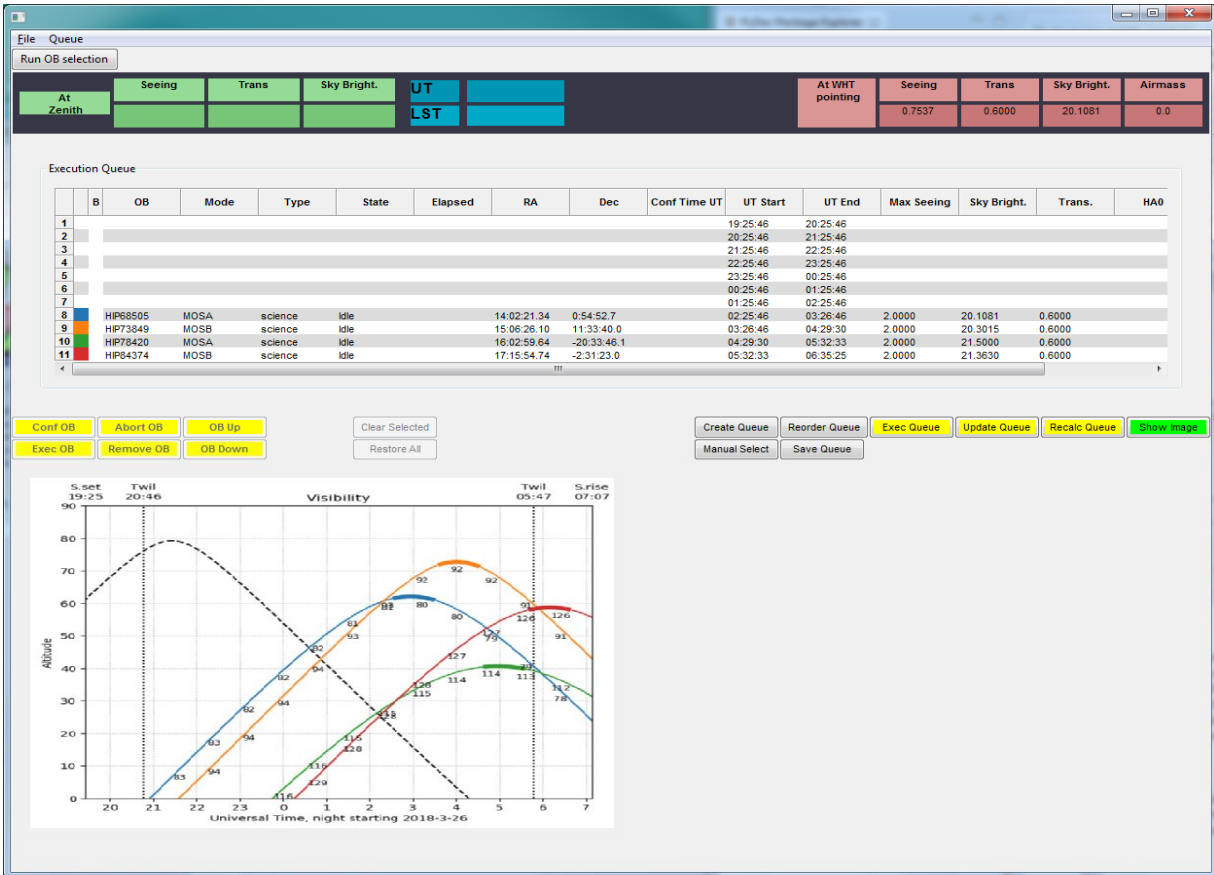

Figure 4 Snapshot of the current status of the Scheduler GUI

5.4 Observation Sequencer

The purpose of the Observation Sequencer is to use the configuration described in the Observing Blocks to physically set up the WEAVE instrument accordingly, and then execute a series of calibration and science integration frames as described within them.

The WEAVE Sequencer will be built upon an existing ING Software tool: **the Sequenciador**. the Sequenciador is a tool that allows not only the execution of general purpose sequences of software actions, but also permits their definition.

The Sequenciador is divided into two parts:

- The Sequence Builder
- The Sequence Executor

The Sequence Builder is used by the ING engineers and astronomers to create and maintain the sequences associated with the execution of the tasks related to the WHT observing system.

The Sequence Executor is used to execute the sequences defined with the Sequence Builder.

In this environment, a **sequence** is defined as an ordered list of steps. A **step** is an ordered list of **actions** and their associated **checks**. A step groups a set of actions, logically related, together with the checks needed to ensure they have been correctly executed. For example, in an OB sequence, a step would be 'Configure Spectrograph', grouping all the actions and the corresponding checks needed for the spectrograph set up.

Actions and checks are the smallest units of a sequence. They implement a single action (e.g. trigger the spectrograph action ‘change resolution’), and specific checks (e.g. check that the spectrograph resolution has been changed without any error).

Both actions and checks are implemented in **functions** (actual Python code) and stored in **modules** (which allows their reuse in any other sequences).

Figure 5 shows the structure of an OCS sequence

Sequence structure

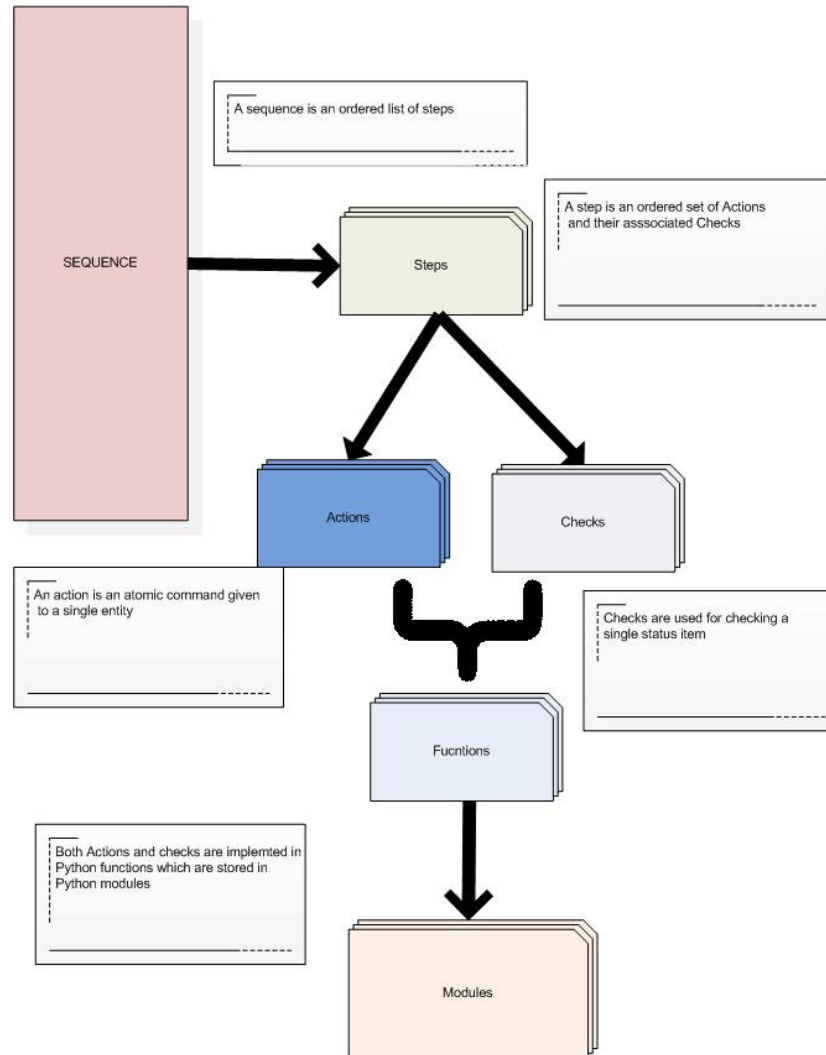

Figure 5 Structure of a WEAVE sequence

The WEAVE OBs are a particularization of the Sequenciador sequences, where the created sequences are dedicated exclusively to OB execution.

Using the WEAVE Sequencer Interface, the WEAVE operator will be able to execute the sequences. The ability to abort and pause sequence execution is also included.

In case a problem occurs during the execution of a sequence, the user will be able to repeat the execution of a sequence step.

The execution of an OB must take place whilst the configuration of the next OB is being carried out on the other plate¹. To accomplish this, the WEAVE sequencer will instantiate the Sequenciador's sequencer object twice; one will be dedicated for each plate (or dedicated to LIFU mode). Depending on the command received, an OB sequence or a plate-configuration sequence will be started in the sequencer dedicated to each plate. In order to ensure the consistency between those commands and the actual positioner configuration, the WEAVE Sequencer will consult the ParameterNoticeBoard for information regarding the state of the tumbler¹. This information will include details about the tumbler status (e.g. stationary or moving) and which observing plate is in the focal plane. Each sequencer object will have an associated Execution Panel, where the user can interact with each sequence.

Sequencer GUI

The WEAVE Sequencer GUIs are an extension of the Sequenciador Execution Panel. They are the GUIs where the operator interacts with the OB execution and plate configuration processes. There is one GUI for each plate. The normal operation of the WEAVE instrument involves simultaneous execution of an OB on one plate and configuration of the fibres by the Positioner on the other plate.

In addition, the Sequencer GUI will allow the execution of non-OB sequences which the user can choose from the list of existing sequences defined in the Sequenciador. To achieve this, the Sequencer GUI allows two user-selectable modes; the OB mode and the user mode.

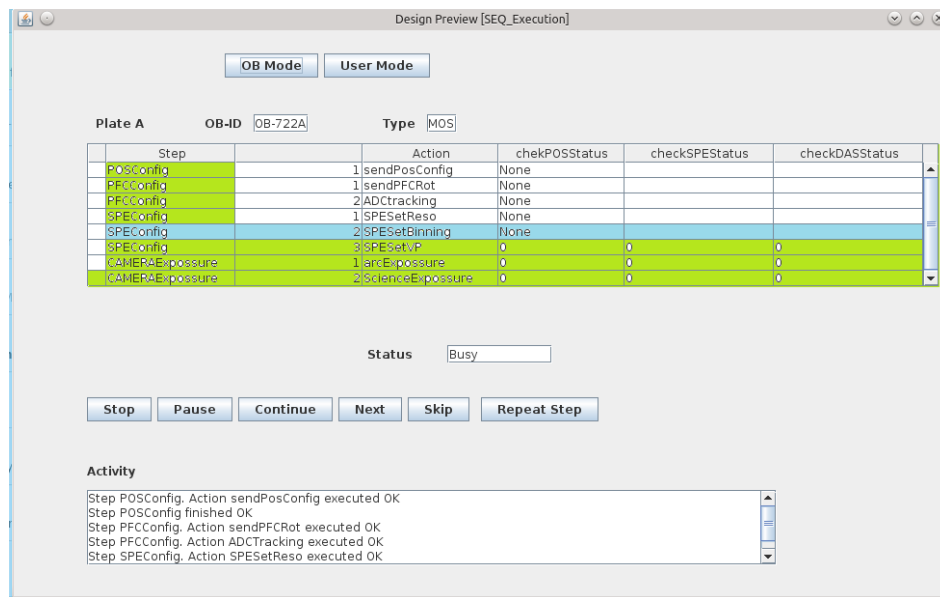

Figure 6 Mock-up for the Sequencer GUI

5.5 Spectrograph control system

The WEAVE spectrograph control system software consists of a suite of components that will permit the WEAVE operator to visualize the status of the spectrograph³ and control the individual mechanisms that comprise the instrument subsystem. Control of the spectrograph will be performed from various sources: the observing block sequencer, the command line, or from a graphical control application. In addition, an Engineering Interface will be provided for engineering and testing purposes.

All status and control requests are routed through a centralized server on the OCS (the **spectrograph high level server**) which has the responsibility of coordinating the control of the **spectrograph embedded control system**⁴, which is based on PAC technology. This is implemented in a manner that is congruent with the techniques that have been utilized with

the successful PAC conversion of various WHT facility instruments, using RSLogix 5000 and Allen Bradley ControlLogix processors. This facilitates the reuse of existing code that has been tested operationally and has proven to be reliable.

This control system will be responsible for performing the actions requested under the constraints of reliability and time. It will also be responsible for updating the internal data structures⁴ with an accurate snapshot of the instrument state. In practice, it will not be aware of which external component is requesting a demand (in fact, the Engineering Interface and the high-level software will use the same method). The PAC will provide a general way to accept demands using a very simple and effective approach: allowing a subset of global variables, which will send instructions to the PAC, to be written by an external component on demand.

The High-Level Server is a dedicated OCS component that will be the single point of access to the PAC from the OCS, centralizing demands and publishing mechanism information. The High-Level Server will be responsible for responding to the OCS clients, performing the actions requested, and for propagating all the information to the upper-OCS layers.

The communication between the low-level and the high-level layers is established using the standard **PLCIO** library, which allows High-Level Server mapping of the PAC memory and the reading and writing of data. In this way, the embedded code does not assume the responsibility for updating the upper layers. It is just responsible for updating the internal data structures that will be read by the High-Level Server.

It also the responsibility of the High Level Server to update the relevant statuses on the Parameter Notice Board, from where any client can gather the information.

In addition, the High-Level Server is responsible for publishing messages in the Message Handler system and to offer the interface which allows any client to perform requests.

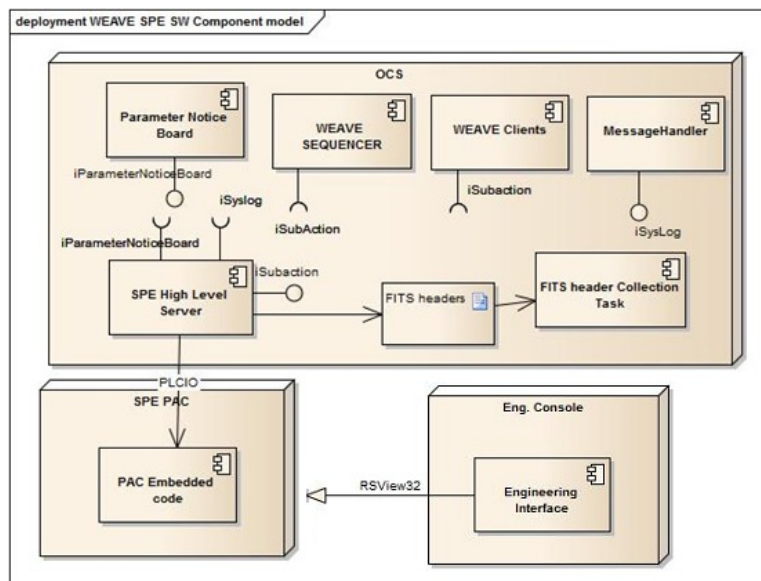

Figure 7 SPE control system component model

The Spectrograph GUI

The purpose of this control panel is to provide high-level control of the spectrograph for engineering purposes and for working with the WEAVE instrument outside of the normal constraints of the observation sequencer. All control of mechanisms provided by this interface in the spectrograph will be subject to the constraints imposed by the various low-

level interlocks designed to protect the system. Furthermore, engineering type control of the spectrograph mechanisms will be restricted when WEAVE is in the operational state.

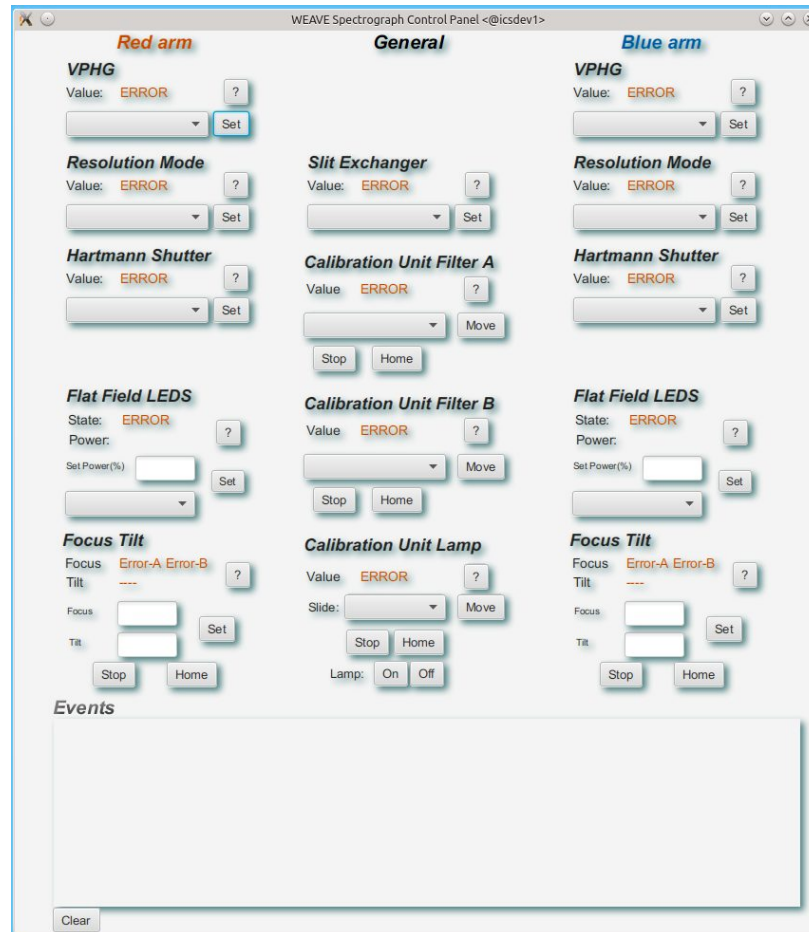

Figure 8 Snapshot of the current SPE GUI development

5.6 Data acquisition and Autoguider systems

Both the data acquisition system and the autoguider system for WEAVE are based upon the existing standard data acquisition system component that is currently used for science operations at the ING. This component is commonly known as **UltraDAS** (UDAS).

UDAS is based upon [ARC](#) detector controller technology. A PCI interface card provides a fibre-optic link to a controller that has the ultimate responsibility of controlling the detector. UDAS is written in the C and C++ programming languages.

The autoguider system for WEAVE is provided as an additional layer on top of the UltraDAS camera system. It will contain the necessary logic to acquire acquisition frames and process them, remove the initial pointing error and generate tracking corrections that will subsequently be offloaded to the TCS. The autoguider will be capable of using multiple guide objects as input to the algorithm that calculates the compensation for the tracking errors and will also be capable for compensating for the effects of differential refraction across the field plate in the case of mIFU/MOS mode observations.

It will be automated to minimise human interaction and thus optimize science operations.

There will be three distinct UltraDAS machines: one for the red arm, one for the blue arm, one for both the LIFU mode and MOS mode autoguider.

The autoguider system for the WEAVE MOS modes is being written in Python 3.5 while the standard autoguider system for the WEAVE LIFU mode is written in the JAVA programming language.

All inter-process communication utilizes CORBA as the communication middleware layer.

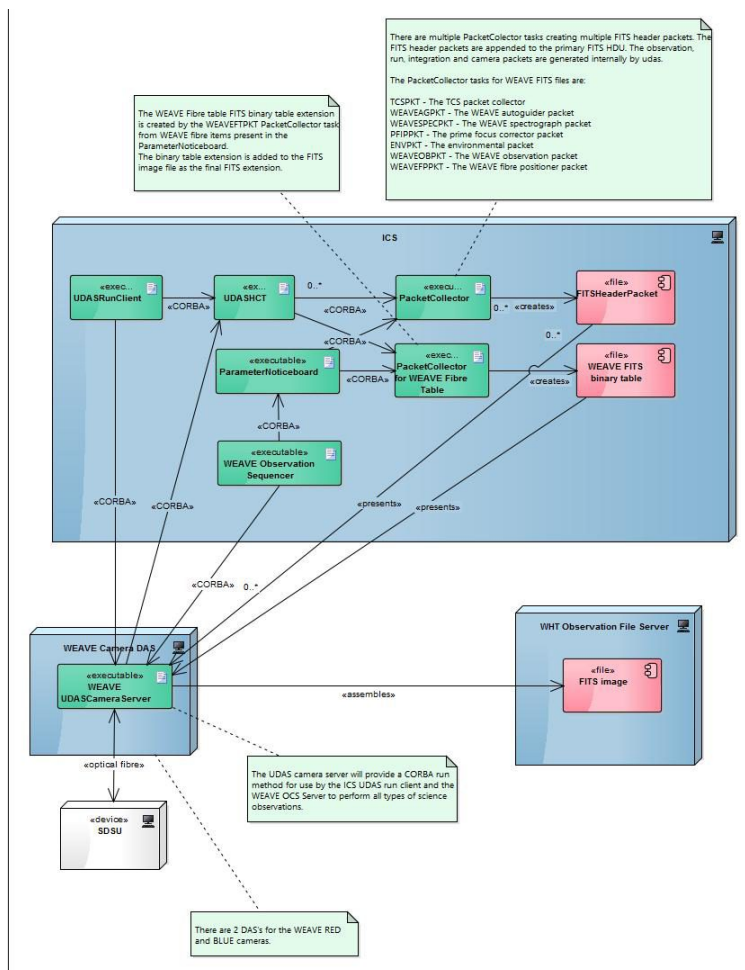

Figure 9 UDAS deployment model

The UDAS Client Interface

The UltraDAS client interfaces will comprise a set of facilities through which engineers and WEAVE operators can initiate the production of FITS images by the data acquisition system and control the parameters associated with the production of them.

The user will be able to visualize the current status of either of the science detectors. The visualization will be performed using a standard data visualization component of the WHT ICS. All these graphic facilities will poll the Parameter Notice Board every second for all the relevant information regarding each detector.

Figure 10 shows the different GUIs related with UDAS and AG systems

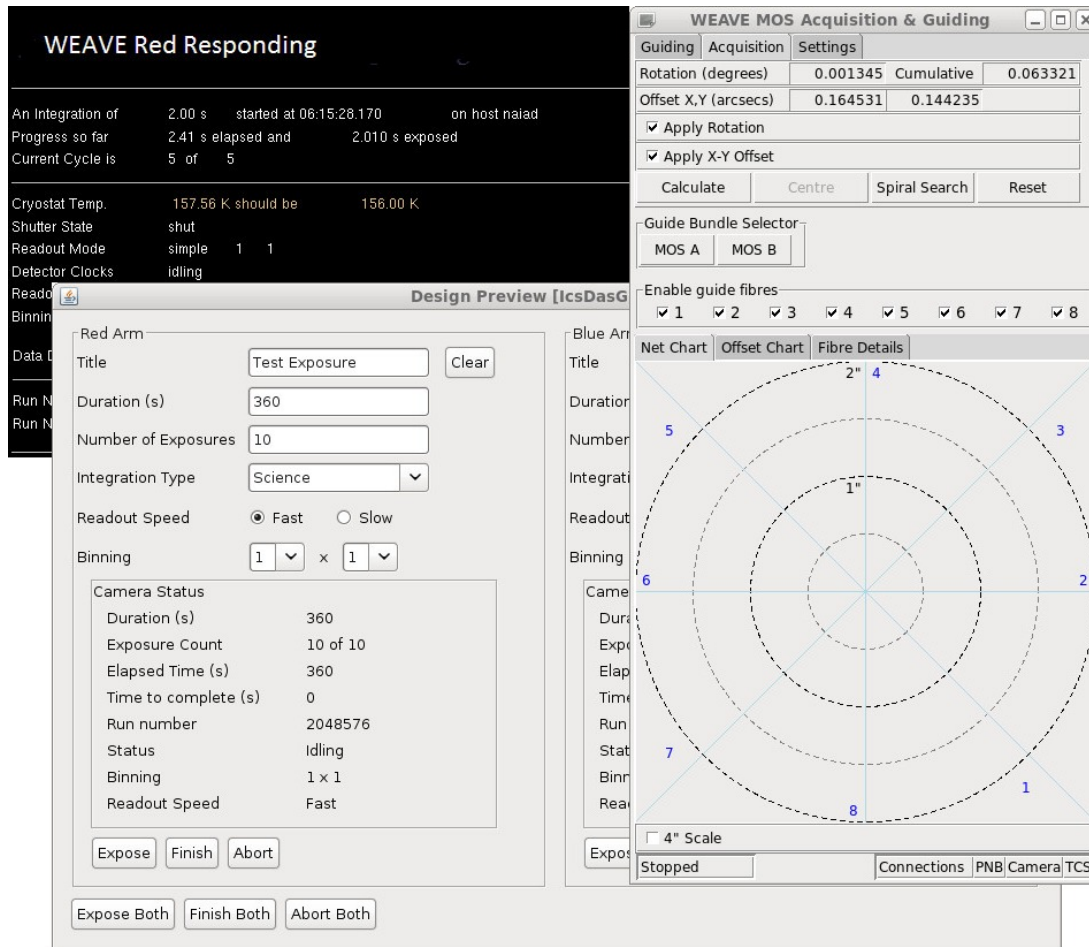

Figure 10 UDAS and AG MIMICS and GUIS

5.7 The Positioner OCS Server

The Fibre Positioner OCS Server (POSOCS) is responsible for collecting the information from the Positioner and creating the associated FITS headers. POSOCS will continuously poll once per second the Positioner server.

POSOCS is a Python 3-based application performing the following tasks:

- Make information regarding the Positioner available to the OCS.
 - POSOCS is responsible for publishing all the Positioner related information into the PNB.
- Building the Positioner-related FITS headers
 - An important set of the information published by this server, into the PNB, is the Positioner FITS headers, the Fibre Positioner system FITS header packet and the Fibres table extension, that will be included in the FITS files produced by the WEAVE instrument.
- Converting captured FPI images to FITS format
 - The focal plane images produced by the Positioner software are in a RAW format. The POSOCS component will be responsible for storing them in the FITS format when the user decides to.

POSOCS Control panel

The WEAVE ICS will possess a panel that will permit the WEAVE operator to control the Fibre Positioner subsystem⁹.

This component will interface with the Positioner server via its CORBA interface and retrieve its status information from the Parameter Noticeboard which is fetched by the POSOCS server. The Positioner GUI that will be provided can be found in Figure 11:

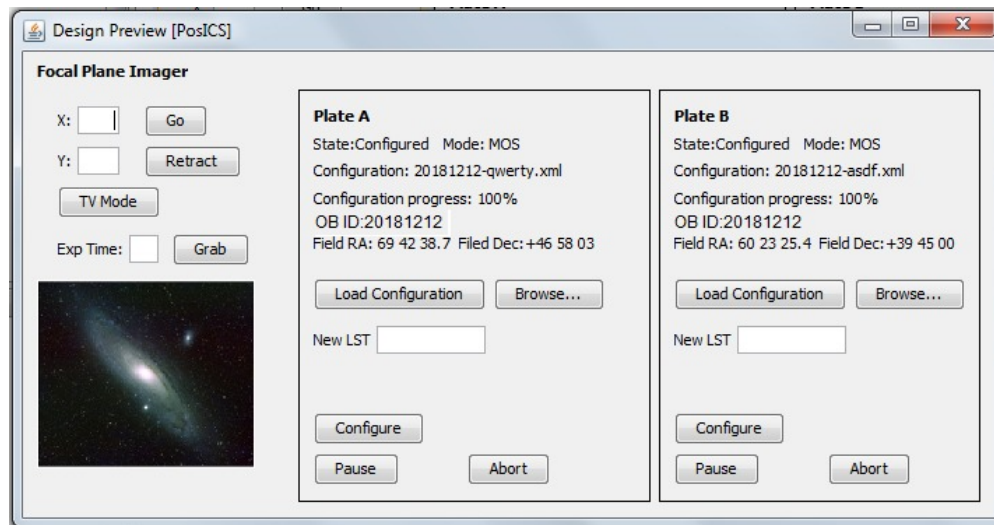

Figure 11 POSOCS control panel

6. OBSERVING BLOCK LIFE-CYCLE

The life cycle of an OB is as follows:

- When an OB is created, the OB Manager will set its state to **NEW**. 'NEW' means that the OB has not yet been attempted but is believed to be in a state to be observed.
- An OB is placed in the execution queue by the Queue Scheduler (only OBs in the NEW state can be scheduled), changing its state to '**SCHEDULED**'. This component will feed the OB Sequencer with the next OB to execute.
- When the Sequencer starts the execution of an OB, it sets the OB state to **IN-PROGRESS**, indicating that the OB is being carried out.
- If the execution of the OB completes without any errors, then the state is set to **EXECUTED** by the Sequencer. In this state, the quality of the data has not been assessed by the Quick-look Module (QLM).
- If the QLM analysis shows that the data meet the SNR requirement, the QLMWatcher will set the state of the OB to **COMPLETE** in the OB Database. COMPLETE means that the OB was executed with success.
- If the QLM analysis is not acceptable, then the QLMWatcher sets the OB state to **INCOMPLETE** and the On-island Survey Management Team (OISMT) will need to investigate the problem.
- If the team identifies a local problem (that could be related to, for example, bad weather, a misconfiguration of the light path anywhere from the dome to the CCD, or high readout noise), then the state is left as INCOMPLETE. INCOMPLETE OBs can later be completely or partially cloned, see below.

- For INCOMPLETE OBs, where the OISMT or the observer has not identified a local problem, the state will be set to **BAD**. This is a manual process carried out using the OB Manager GUI. An OB in a BAD state is an observation that is not acceptable but the reasons are still unknown. The results of the observation will be further investigated.
- The execution of an OB can be interrupted for several reasons. If there is an insurmountable problem during the instrument configuration (i.e. before any exposure has been taken), the Sequencer will set that state of the OB to **ERROR**.
- If the instrument configuration was successful, problems can still arise later during the acquisition and exposure phases. Those problems can be due to local problems (instrument configuration or environmental, as for example a sudden change in weather conditions) or a problem with the definition of the field (for example no guiding is possible because the fiducials are incorrectly defined). In this case, the sequence will be interrupted and the Sequencer will set the OB state to ERROR.
- In addition, time constraints could force the observer to abort the execution of an OB. In this case, the Sequencer will set the OB state to ERROR.
- All OBs with a state of ERROR will be treated in the same way requiring that an analysis be performed by the OISMT in order to decide which state to change the OB to. The observer must write a comment, which will be associated with the OB, indicating the origin of the problem.
- The OBs which state is ERROR must be examined by the OISMT, who will determine if the origin of the problem was local (instrument configuration or environmental conditions) or was due to an incorrect definition of the field held in the received XML file (for example, bad astrometry or guide stars too faint). In the first case, the observer will manually set the OB state to INCOMPLETE (so it can be cloned later). Otherwise they will change the OB state to BAD (so it can later be marked as REJECTED and sent back to the SWG).
- A cloned OB will be changed to the **CLONED** state as a final state indicating that a new OB has been created with the remaining or all exposures. An OB that has been created via cloning, to complete a previous OB, will be set to the NEW state when by the OB Manager internally referencing its antecessor.

Figure 12 shows the machine state associated to the OB life-cycle:

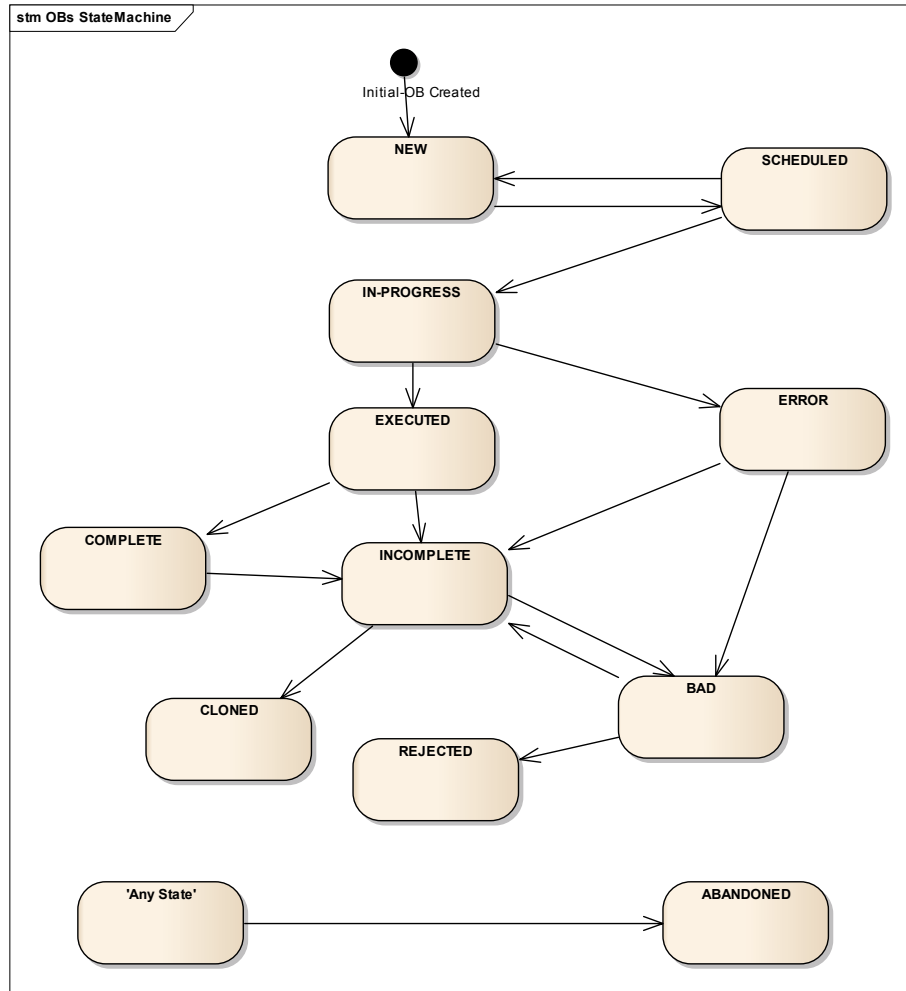

Figure 12 State Machine for the OB Life Cycle process.

7. SOFTWARE TESTING PLAN FOR THE OCS

To minimise system failures, the software that has been designed for the WEAVE OCS will be tested using both black-box as well as white-box testing techniques. This approach will allow for the design of appropriate test cases that will be used to verify the software products with respect to the requirements and their specifications.

The test environment is designed to allow all software tests, which do not require on-sky access, to be carried out within the telescope and not affect active operations. The environment will cover all aspects of the data flow from reception of the target fields from the Survey Working Group to delivering the FITS files to CPS and WAS.

The structure of the test environment is similar to the operational setup at the WHT with the exception that the created FITS files are not archived and the hardware components are, in the first instance, simulated.

The current TCS and DAS are equipped with simulation modes. The spectrograph and the Prime Focus Control Systems will have also simulation modes.

The OCS Team, along with the Instrument Scientist, will execute the test activities to verify that the OCS meets the system requirements.

The OCS will be progressively assembled and integrated during stage four such that:

- subcomponents are assembled into complete components

- components are assembled into assemblies
- assemblies are assembled into subsystems
- subsystems are integrated into the OCS

At each level of assembly and integration, the components, assemblies, subsystems, and system will be subjected to a level of testing that maximises the chances of the complete OCS being fit for purpose.

Testing will consist of the following test cycles:

- Unit testing – to ensure that the code is working as intended. Tests will be refined to the smallest testable pieces of code and will be carried out by the developer.
- Intra-system integration testing – to test the interactions of the OCS interfaces within the system
- Observatory Control System testing – to test that the OCS works as a single entity
- Inter-system integration testing – to test the interactions of the OCS with its external interfaces
- User acceptance testing – this will be part of the commissioning phase and is to ensure that the delivered system is fit for purpose as defined by the Instrument Scientist

8. REFERENCES

- [1] Dalton, G.B. et al, “Final design and progress of WEAVE: the next generation wide-field spectroscopy facility for the William Herschel Telescope“, paper 10.1117/12.2231078, SPIE conference 2016
- [2] Dalton, G.B. et al, “Construction progress of WEAVE: the next generation wide-field spectroscopy facility for the William Herschel telescope”, paper 10702-47, this conference.
- [3] Stuik, R. et al, "Integration and testing of the WEAVE spectrograph", paper 10702-275, this conference
- [4] Salasnich B. et al, "Low Level Control Software for the WEAVE Spectrograph", paper 10707-69, this conference
- [5] Canchado M et al, "The WEAVE focus translation system: from design to construction", paper 10.1117/12.2232985, SPIE conference 2016
- [6] Walton W. et al, “WEAVE core processing system”, paper 10.1117/12.2055457, SPIE conference 2014
- [7] Guerra J. et al, “WAS: the data archive for the WEAVE spectrograph”, paper 10.1117/12.2231300, SPIE conference 2016
- [8] Rogers K. et al, “The design of the WEAVE spectrograph”, paper 10.1117/12.2055860, SPIE conference 2014
- [9] Lewis I. et al, “Fibre positioning concept for the WEAVE spectrograph at the WHT”, paper 10.1117/12.2055883, SPIE conference 2014
- [10] Farina C. et al, “The observation queue scheduler for WEAVE on the WHT”, paper 10704-34, this conference.